

## EST Grain Silo Temperature & Level Monitoring System



### SYSTEM INTRODUCTION

Temperature is a key factor for maintaining grain quality in a grain storage system. When the grain has suffered from deterioration, corrosion or pest and disease damage, the temperature is increased inevitably. If precise temperature information of the grain can be mastered, an air conditioning system can be more efficiently controlled to achieve high efficient energy management.

For silo management, an EST system can measure grain temperature in silo and measure stored grain level synchronously, thereby not only instantly tracking and recording grain conditions, recording historical records, but also providing optimal grain storage quality monitoring.

The EST can be matched with the FineLink hub series, and employs an RS485 communication interface to transmit information to a central control room or a human-machine interface via wire or wirelessly.

The EST is matched with MMSTLA silo information and integrated with monitoring software, so that a user can easily monitor dual information, both the temperature and grain level in the silo, through a remote computer, thereby performing grain storage management with the utmost convenience and efficiency.



## EST10000-A Multi-Point Temperature Sensor

EST10000-A multi-point temperature sensor wire can measure temperature of grain in different positions of the silo in real time, to record condition of the grain and provide you the optimal monitoring of grain storage quality.

Relative to the traditional silo, manual temperature measurement is time-consuming and arduous.

The temperature measured by EST10000-A is digital signal, which can output RS485 communication mode through matching with FineLink 1-wire to transmit information to the central control room or human-machine interface. The user can easily know the grain temperature in the silo only from the remote end and conduct the most efficient grain storage management.

### FEATURES

- Reinforced steel cable design can effectively resist the impact of grain and prolong service life of the product.
- Provide multi-point temperature measurement to help managers cope with food more swiftly.
- Detect whether there is fungus produced or activities of insects, to maintain food quality.
- Provide real-time monitoring of silo temperature for practitioners in food, fodder and grain, to help long-term storage.
- Prevent qualitative change of grain in the silo and fire disaster due to smolder.
- Temperature measurement position can be customized according to customer's requirements, which can be hung outside or built in the silo.

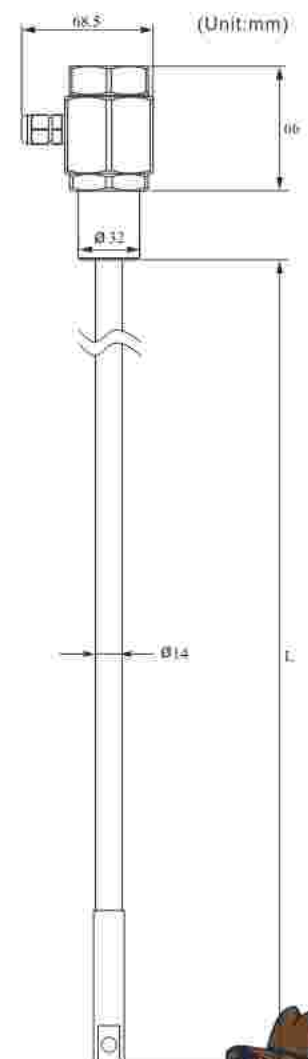
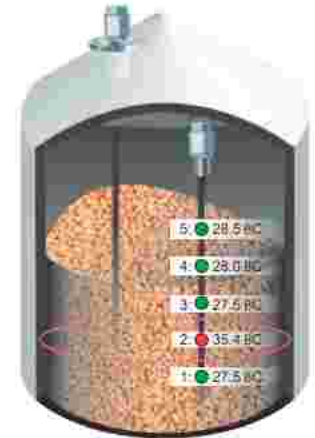

### SPECIFICATIONS

Measurement range	-10 ~ 85C
Resolution	0.1°C
Accuracy	+/- 0.5° C
Length Max.	Max. 30m
Quantity of sensors	Max. 30pcs
Position of sensors	One sensor is built in every meter
Cable material	Coated with XLPE, inner ring is copper wire (Standard)
Tensile load	2500 Kgf
IP rating	IP67
Housing material	SS41 Low-carbon steel
Outgoing cable diameter	ø 4~7mm
Ambient temp. (Ta)	T800C: -40<Ta<700C T950C: -40<Ta<800C



## EST10000-B 2 in 1 Grain Temperature & Level Monitoring Transmitter

For silo management, users must install temperature sensing wire and grain level sensor separately in the past to get the information of temperature and grain level. EST10000-B two-in-one silo temperature and grain level meter can synchronously measure grain temperature and level in the silo, to track and record grain condition, so as to provide you the optimal grain storage quality monitoring.

EST10000-B adopts the RS485 communication interface, to transmit information to the central control room or human-machine interface. Users can monitor dual information of grain temperature and level in the silo from the far end, to conduct the most convenient and efficient grain storage management.

### FEATURES

- Unique in the industry, EST10000-B transmitter integrated with simultaneous monitoring of grain level and temperature
- Steel cable design can effectively resist the impact of grain and prolong service life of the product.
- Provide real-time multi-point temperature measurement to help managers cope with food more swiftly
- Detect whether there is fungus produced or there are activities of insects, to maintain food quality and facilitate long-term storage.
- Prevent qualitative change of grain in the silo and fire disaster due to smolder.
- Temperature measurement can be customized according to customer's requirements.
- Any two points of EST10000-B are in simple calibration mode of grain level.
- The product uses open main current communication interface RS485. The system user
- can install the device on any system having the communication interface.



### SPECIFICATIONS

Power input	9~30 Vdc
Measurement range	-10~85C
Resolution	0.1C
Accuracy	+/- 0.5°C
Length	Max. 30m
Quantity of sensors	Max. 30pcs
Position of sensor	One sensor is built in every meter
Sampling speed	Grain level measurement: <1 sec Temperature measurement: <1 sec/node
Non-linearity of grain level	+/- 1% FS
Output interface	RS485; Baud Rate: 9600~57600 bps
Material of junction box	Aluminium alloy (ADC-12)
Outgoing cable diameter	ø 4~7mm
Cable material	Coated with XLPE, inner ring is copper wire
Tensile load	2500 Kgf
IP rating	IP 67
Ambient temp. (Ta)	T80°C: -40<Ta<70°C T95°C: -40<Ta<80°C



## Installation Quantity Guide

If the silo is bigger than 8 meters in diameter, we suggest the customer follows our guide of sensor number and sensor installation position to guarantee system can totally monitor temperature change of material inside the silo.

Silo diameter	EST Sensor Number	Silo Center	First Cycle			Second Cycle			Third Cycle		
			Radius (m)	Quantity	Interval Angle	Radius (m)	Quantity	Interval Angle	Radius (m)	Quantity	Interval Angle
411											
611											
8302.33120											
10302.53120											
12413.33120											
14614.7572											
16715.6660											
18816751											
201102.531207.5845											
221202.831208.2940											
241303312091036											
261715.366010.61036											
281916.666010.61230											
302202.631207.575112.81230											
362902.531208.5103614.51622.5											
403415.657211.31036171820											

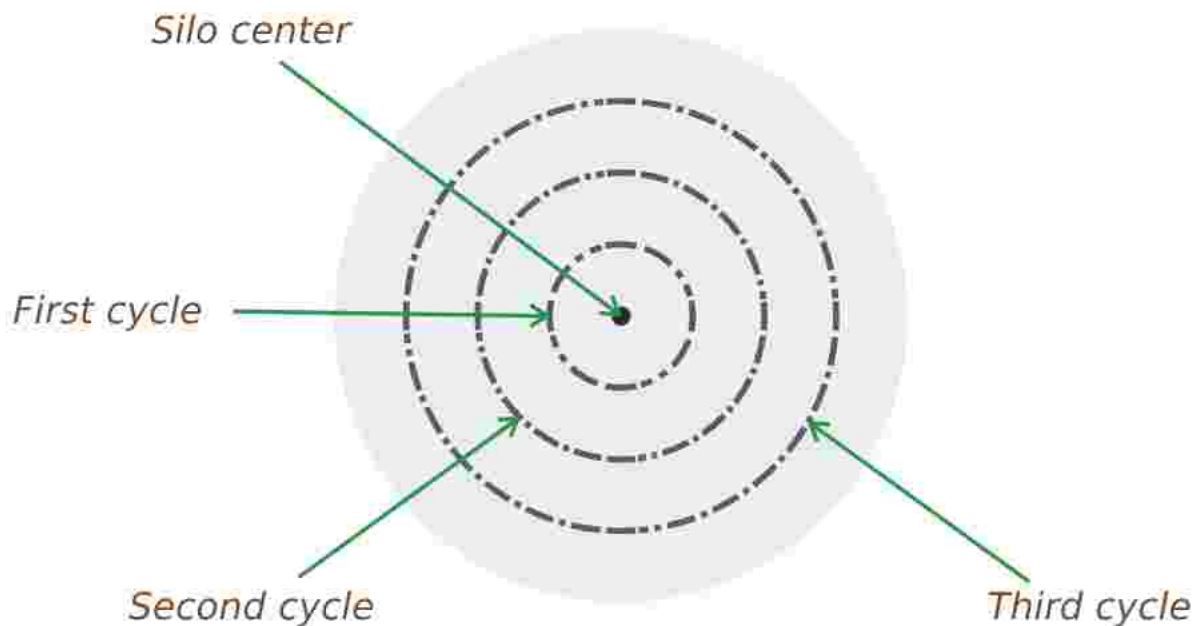

**Order Information**

EST1 0 0 VV -VVVVVVVVVV VV VVVV V

⑦⑧ Certification

- 00: None
- 1B: ATEX-Exia
- 2B: IECEX-Exia

⑨ Type

- Aw Multi-point temperature sensor
- Bw 2 in 1 grain temperature & level monitoring transmitter

Connection

⑩⑪

- 00 w None
- Flange item
- AKw JIS-FF==
- ANw ANSI-R F
- ASw DIN-FF

⑫⑬

- 00 w None
- A9 w 1-1/4 "
- B1 w 1-1/2 "
- B2 w 2"
- B4 w 2-1/2 "
- B5 w 3"
- B7 w 4"
- B8 w 5"
- B9 w 6"
- D9w DN32
- E1w DN40
- E2w DN50
- E3w DN65
- E4w DN80
- E5w DN100

⑭⑮

- 00 w None
- 03 w PF male
- 07 w NPT male
- 40 w 5kg/cm<sup>2</sup>
- 42 w 10kg/cm<sup>2</sup>
- 48 w 150Lb s
- 49 w 300Lb s
- 57w PN10
- 58w PN16

☒ The standard connect of EST10000-A is 000000  
The standard connect of EST10000-B is AAA903

(Next page )

⑯⑰ Connection material

- MAw SUS304
- MDw Low carbon steel
- MHw Aluminum alloy



**Order Information cont.**

EST1 0 0 0 0 -VVVVVVVVVV VV VVVVVV

⑱⑲ Sensor interval

- 05w One sensor every 0.5m
- 08w One sensor every 0.8m
- 10w One sensor every 1.0m
- 15w One sensor every 1.5m
- 20w One sensor every 2.0m
- 28w One sensor every 2.8m



95w One sensor every 9.5m

Temp. sensor interval=cable length ÷ numbers of temp. sensor.  
 Lowest interval = lowest temp. sensor to end of cable is fixed to be 30mm.  
 Highest interval (L1) = sensor interval -30mm.

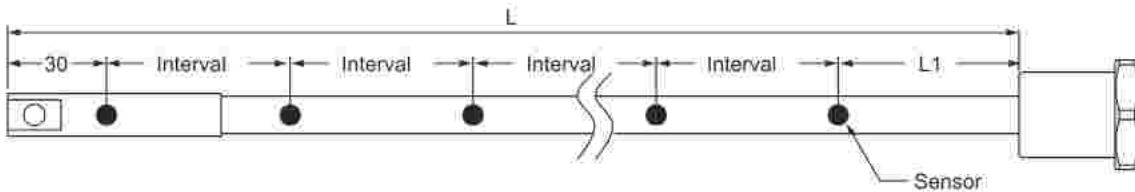

⑳㉑ Sensor amount

- 01w 1 Pcs
- 02w 2 Pcs



30w 30 Pcs(Max)

㉒㉓㉔㉕ Length

Code	Probe Length
0500~9999	500~9999mm
A100~A300	10000~30000mm 5A5R means multiplied by 100 times



## FineLink System Hub (1 to 8)

The multiple measuring data in one sensor will be interpreted by FineLink through RS-485 signal and send out to PC or other human machine interface.

So the immediate temperature status can be monitored. In order to prevent infestation of pest in the storage when there is temperature changes.

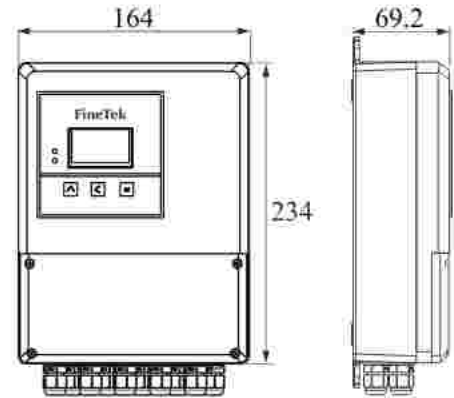

(Unit:mm)

### SPECIFICATIONS

Input power supply	12~28 Vdc
Ambient temp.	-40~80°C
EST110	8
Housing material	Aluminum alloy (ADC-12)
RS-485 baud rate	RS-485
Cable diameter	1200~57600
Cable isolated thickness	ø 4~7
Communication interface	>0.5mm
IP rating	IP67
ATEX	ATEX II 1D Ex IIIC T80°C, T95°C Da ICEC Ex ia IIIC T80°C, T95°C Da (Need to match the barrier with same Exia explosion proof)

### Order Information

**JMW 6**

Construction \_\_\_\_\_  
01: Wired

Certification \_\_\_\_\_  
00: None  
1B: ATEX-Exia  
2B: IECEx-Exia

Function \_\_\_\_\_  
A4: 1-wire



## RCU2 Remote Control Unit

Remote Control Unit 2 (RCU2) is the solution for small and medium system with total sensor less than 8. RCU2 can be located on the wall at desired installation location, provide the display screen with touch user interface.

The control unit is intuitive and convenient with the easy-to-use touch screen. RCU2 read data from sensor via RS485 interface, display on the screen, and can transmit to PC also.

### FEATURES

- Easy-to-use touch screen, simple operation
- Using Microcomputer control, the operation time is more accurate
- Anti-electric shock designed box, protect components inside
- RS485 communication interface (Modbus protocol)
- Integrated memory storage, can record data up to 90 days
- User Setting is available



### SPECIFICATIONS

Power supply	100~220Vac, 50/60Hz
Display	7 inches (800*480) TFT LCD
Touch panel	Resistive touch
Voltage output	24Vdc (Maximum of 1A current output)
RAM	128 MB memory storage, 64MB RAM (record data up to 90 days)
Junction box dimensions	296*281*158mm
Operating temp.	0°C to 50°C (20°C to 50°C Optional)
Storage temp.	-20~60°C
IP rate	IP65
Maximum input sensors	8 sensors
Input/Output interface	Comport*2 (COM1: RS232 / COM2: RS485 2W/4W)

## RCU2 Remote Control Unit

**RCU 2000**

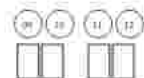

Sensor type (input signal) \_\_\_\_\_  
 A1: EST10000-A Multi-point temperature sensor  
 A2: EST 10000-B 2 in 1 grain temperature & level monitoring transmitter

Communication \_\_\_\_\_  
 A: RS-485  
 B: Zigbee

Operating Temperature \_\_\_\_\_  
 A: Standard type (0~50C/ 32-122F)  
 B: Lower temperature type      °C/ -4~122F (-20~50)



## MMS-TL Materials Management System



### SYSTEM REQUIREMENTS

- Central processing unit (CPU)  
P4 1GHz above
- Memory RAM 512MB above
- Operating system Microsoft  
Windows 2000 above
- At least 1GB idle hardware space  
for database
- RS232 or USB

MMS-TL intelligent grain silo temperature and level management system is a set of PC software, which can replace measurement and record manually and operating method is through configuration of electricity meter and switch.

It can be widely applied to industries such as rice milling, flour, fodder, food, low temperature unhulled rice and grain crop as well as grain level environment that needs measurement of multi-point temperature. It is applicable to temperature and grain level detection in tank and barrel of general power, particle and block.

MMS-TL can monitor temperature change of the silo all the time, to prevent abnormal temperature, so as to avoid damage to the grain. It can also effectively manage entry, stock and sales of grain, to reduce operating cost, so as to increase profit and improve customers' competitiveness.

### FEATURES

- **Set Item:** Tank number, tank name, device number, device model, FineLink 1-Wire general setting, grain high level alarm, grain low level alarm, high temperature alarm, low temperature alarm, series port setting, connection timeout setting, selection of multiple tank types and related parameters corresponding to sizes, alarm sending mode, alarm information receiving mode and account setting and SMTP email server setting, etc.
- **Display Item:** Tank name, grain percentage, grain weight, minimum temperature, maximum temperature, current temperature of each measuring point of a sensing device, temperature change of a certain sensing device's certain measuring point on that day and history information review, etc.
- **Alarm Item:** Grain high/low level alarm, high/low temperature alarm and connection timeout, etc.
- **Report Output:** History information is transformed to text or Excel format.
- **Alarm Mode:** Display it on the screen on the spot and utilize e-mail to transmit alarm information to preset receivers through regional Intranet or Internet.
- **Account Setting:** Set the account for rights of Supervisor or Operator.



## MMS-TL materials Management System



### HOME

User can view all information of each tank in page mode, including high/ low alarm, material height, ratio of remaining material, material weight, sensing weight status, material selection, tank measurement, and motor indication etc.

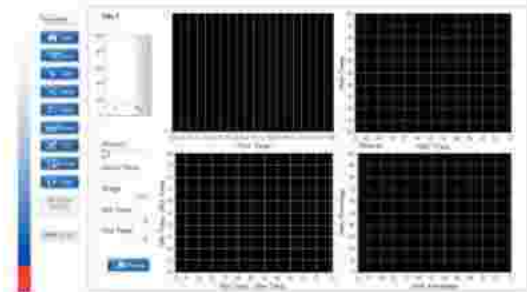

### MATERIAL MANAGEMENT

Daily information can be checked and examined the import /outport material time. Equips with automatic scaling function and mouse point sliding function, let user easy to find the critical point.

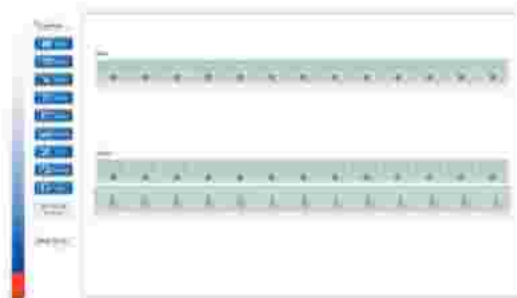

### I/O SETTING

Relay output for level or temperature.



### HISTORY CHART

User can observe all historical messages and transfer data in .txt or EXCEL format standard, let user can analyze data in Windows system.



### ALARM SETTING

This function supports user to get real-time message to predetermined mail message recipients and field operator get the alarm message dialog window at the same time. It save the communication between the field and manage center while the critical situation occurred.

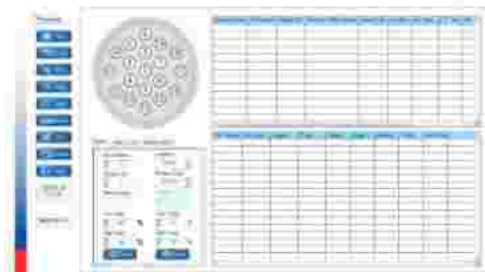

### CONFIGURATION

Can set parameters of each device, including: Silo number, Comport, Product, Type, Density etc.



## IPC Industrial Computer



### FRONT VIEW

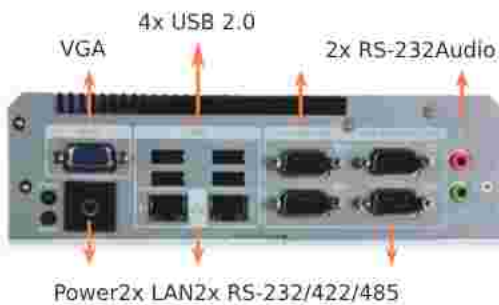

### REAR VIEW

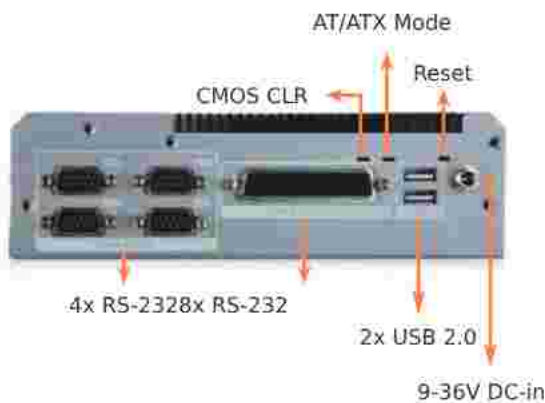

### FEATURES

- Intel® Dual Core D2550 1.86 GHz processor
- 8 COM model: 6 x RS-232, 2 x RS-232/422/485
- 6 x USB 2.0
- Dual PCIe GbE LAN for high-speed network applications

### SPECIFICATIONS

MODEL NAME	TANK-600-D2550	
Chassis	Colour	Black C + Silver
	Dimensions (WxDxH)	193.4 x 200 x 57 mm
	System Fan	Fanless
	Chassis Construction	Construction Aluminum alloy
Motherboard	CPU	Intel® D2550 1.86 GHz dual-core processor
	Chipset	Intel® NM10
	System Memory	On-board DDR3 4GB
StorageHard Drive	1 x 2.5" SATA HDD Bay	
	USB 2.0	6
I/O Interfaces	Ethernet	2 x RJ-45 Realtek 8111E GbE LAN
	RS-232	6 COM: 6 x DB-9 16 COM: 14 x RS-232 by DB-78
	RS-422/485	2 x RS-232/422/485 by DB-9
	Display	1 x VGA
Expansions	Resolution	VGA: Up to 2048 x 1536 @ 75Hz
	Audio	1 x Line-out, 1 x Mic-in
	PCle Mini	1 x Full Size (Support mSATA) 1 x Half size
	Power Input	DC Jack : 9~36V DC
Power	Power Consumption	12V@2.2A (Intel® Atom™ D2550 with 4GB DDR3 memory)
	Mounting	VESA 100, DIN-Rail
Reliability	Operating Temperature	-20°C ~70°C with air flow (SSD), 5% ~ 95%, non-condensing
	Operating Shock	Half-sine wave shock 5G, 11ms, 3 shocks per axis
	Operating Vibration	MIL-STD-810F 514.5C-2 (with SSD)
	Weight (Net/Gross)	2.2 Kg / 3 Kg
OS	Safety/ EMC	CE/FCC
	Supported OS	Microsoft® Windows®7



## FineLink 1-wire/ FineLink 1-wire Wireless

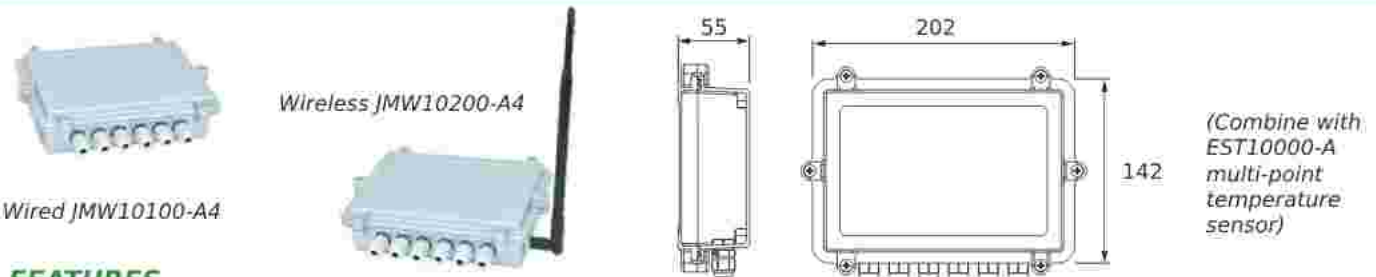

### FEATURES

It extends and connects to the sensor through wired way, which can connect 4 sets of EST10000-A 1-Wire communication modes. Each sensor has an independent connection, which can prevent the whole system from crashing due to a particular equipment failure, so as to make users capable of maintaining multiple equipment more easily. 1-wire digital signal can be transformed to RS485 to make MMS-TL silo temperature and grain level management system or PLC read and use.

### SPECIFICATIONS

Supply voltage	10~30Vdc
Ambient temperature	-40~80BC
Connection port	Max.4
Housing	Aluminum alloy (ADC-12)
Communication interface	RS-485
RS-485 baud rate	9600~115200
IP rating	IP67

## FineLink RS485/ FineLink RS485 Wireless

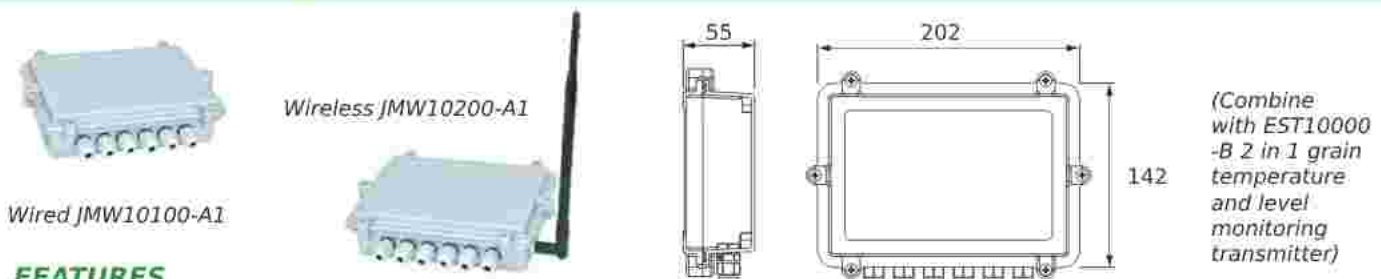

### FEATURES

It integrates 4 sets of signals with RS485 communication mode to make wiring more convenient and clear. Each port is independent, which can prevent the whole system from crashing due to a particular equipment failure, to make users capable of maintaining multiple equipments more easily. 4 sets of 4-wire type connection ports also supply 24VDC power for external device.

### SPECIFICATIONS

Power input	10~30Vdc
Current input	2A
Power output	10~30Vdc
Current output	400 mA / CH (under power input and current of 2A)
Output	RS-485
Input	Four sets of RS-485 (each set is independent and isolated)
Baud rate	1200~57600
Working temperature	-40~80BC
Electrostatic protection	IEC61000-4-2 ESD 8kV Air, 4kV contact
IP rating	IP67



**System Architecture**

**WIRELESS SYSTEM**

Monitor change of level and temperature of grain in tank on each measuring point. (MMS-TL Materials Management System)

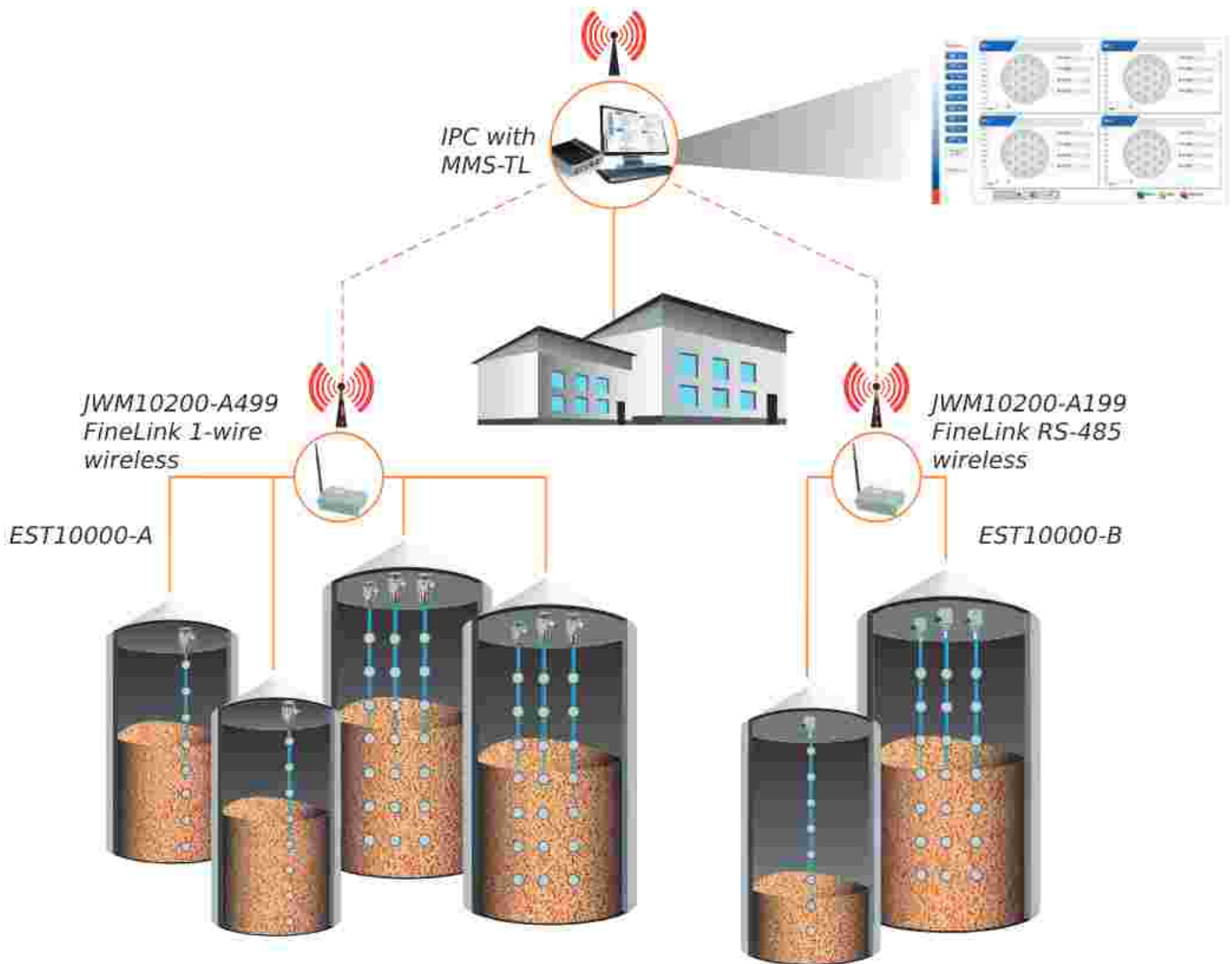

(Wireless system, please refer P15 for more details)



**System Architecture**

**WIRED SYSTEM**



Monitor change of level and temperature of grain in tank on each measuring point. (MMS-TL Materials Management System)



IPC with MMS-TL

RS485

RS485

JWM10200-A499  
FineLink 1-wire

JWM10100-A199  
FineLink Rs485

EST10000-A

EST10000-B

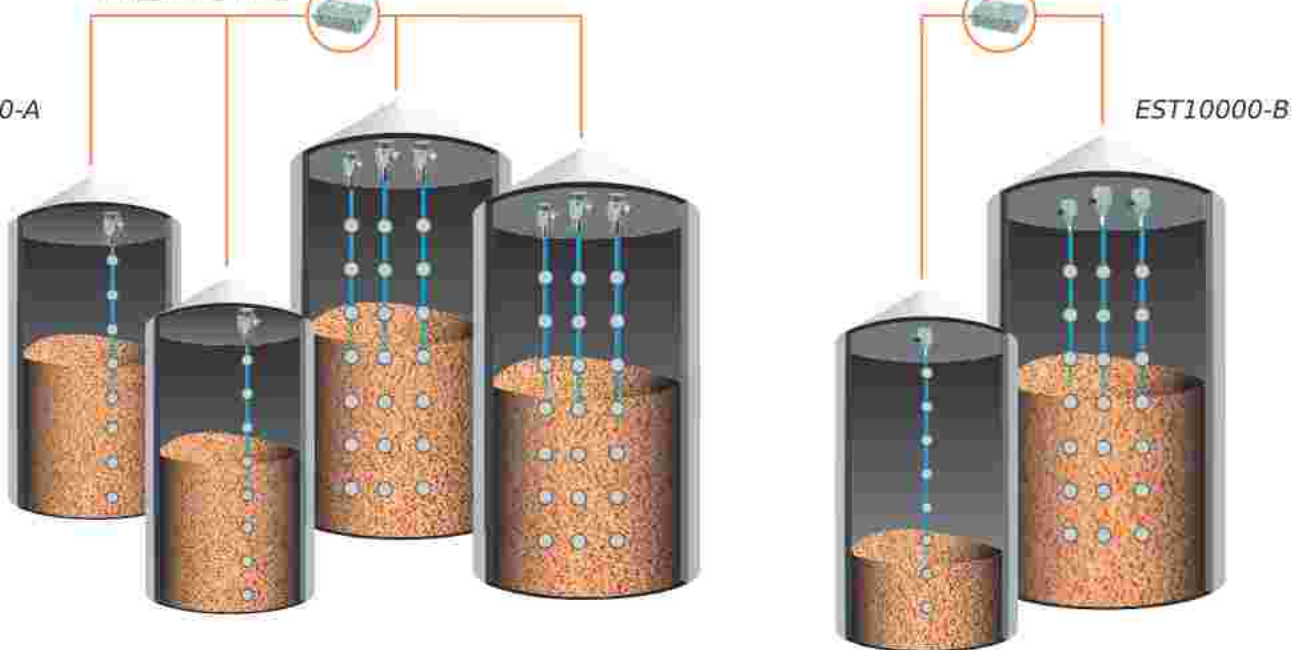

**Wireless System Architecture**

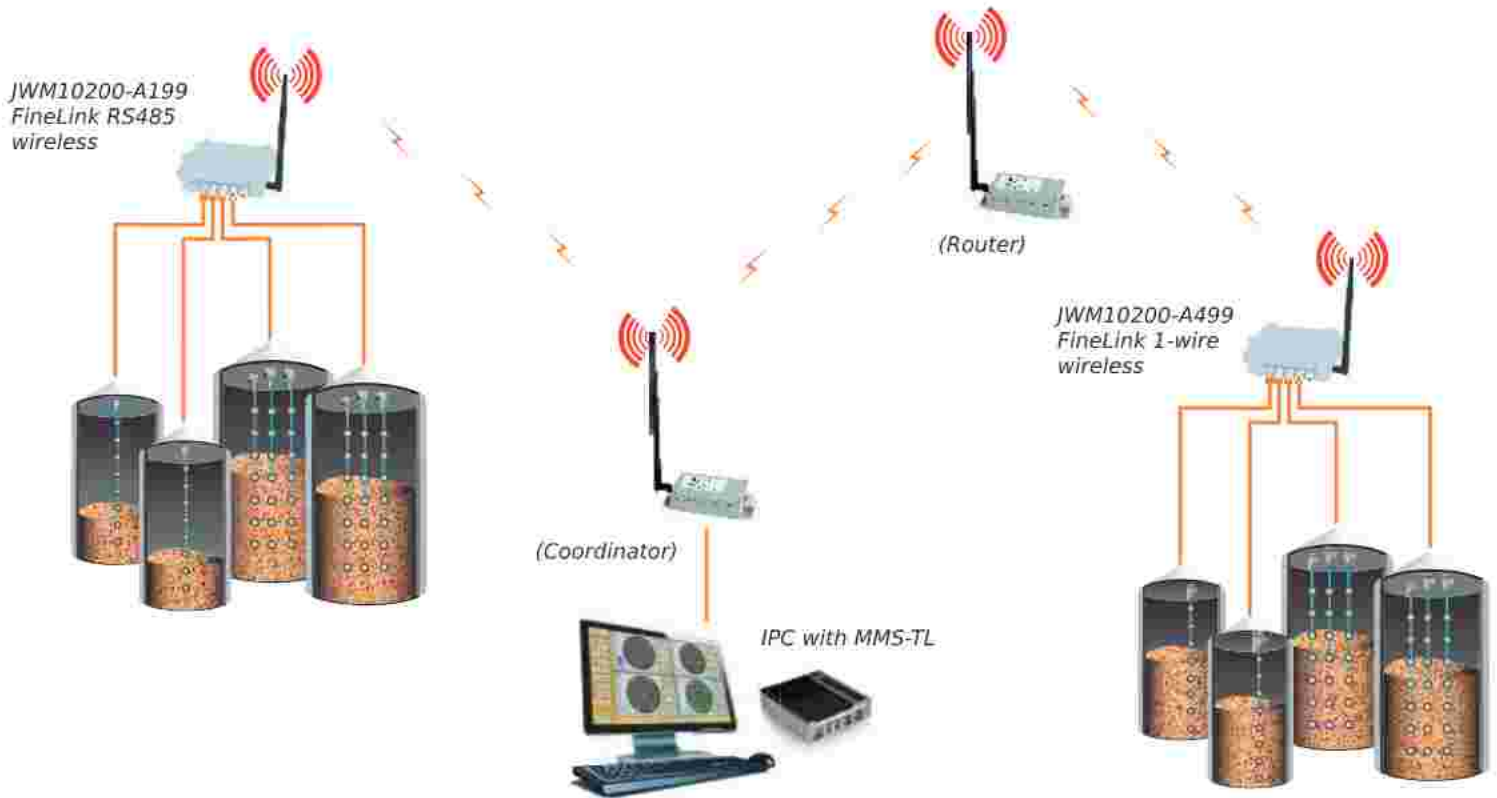

FineLink Wireless uses wireless to transmit RS485 signal, help customer reduce cable and maintenance costs.

**SPECIFICATIONS**

Output communication	RS485
Input communication	FineLink RS485: Rs485 FineLink 1-wire: 1-wire signal
RS-485 baud rate	9600/19200/38400 57600/115200
Storage temp.	-40~80°C
Operating temp.	-40~80°C
Static electricity protection	IEC61000-4-2 ESD 8kV Air 4kV contact
Power input	10V~30V
IP rating	IP67

**WIRELESS COMMUNICATION**

Operating frequency range	2405 MHz ~ 2480 MHz
Number of channels	16 CH
Channel spacing	5 MHz
Data transmission rate	250 kbps
Sensitivity	-100 dBm (PER< 1%)
Transmission range	Max. 2km



## Wireless System Architecture

### COORDINATOR

P/N: JMW20200-0C

Coordinator receives signal from FineLink or Router, then sends to PC or PLC via RS485 interface, MMS software reads and displays the measured data

### ROUTER

P/N: JMW20200-0R

Router increases transmission distance when the wireless signal strength from Finelink to Coordinator is not strong enough due to long distance. Router receives data from FineLink, then enhance and forward signal to Coordinator. then enhance and forward signal to Coordinator.



#### SPECIFICATIONS

RS-485 baud rate	9600/19200/38400 57600/115200
Storage temp.	-40~80°C
Operating temp.	-40~80°C
Static electricity protection	IEC61000-4-2 ESD 8kV Air 4kV contact°C
Dimension	146 X 66 X 30 mm
Power Input	10V~30V
IP rating	IP67

#### WIRELESS COMMUNICATION

Operating frequency range	2405 MHz ~ 2480 MHz
Number of channels	16 CH
Channel spacing	5 MHz
Data transmission rate	250 kbps
Sensitivity	-100 dBm (PER< 1%)
Transmission range	Max. 2km
Antenna specification	3.5mm SMA Female



**Order Information**

**IPC CONTAINS MMS-TL**

MMS/M300 IPC (traditional Chinese WIN7)  
+ MMS-TL  
+ RS485-USB converter (YTXPUSB485-T)  
MMS/M200 IPC(English WIN7)

+ MMS-TL  
+ RS485-USB converter (YTXPUSB485-T)  
MMS/M400 IPC(simplified Chinese WIN7)  
+ MMS-TL  
+ RS485-USB converter (YTXPUSB485-T)

**FINELINK**

Communication Model	Order Code	Communication Interface
FineLink Wired	EST10000-B	JMW10100-A150 Input: RS-485, Output: RS-485
	EST10000-A	JMW10100-A450 Input: 1-wire, Output: RS-485
FineLink Wireless	EST1000-B	JMW10200-A157 Input: RS-485, Output: ZigBee
		JMW10200-A158 Input: RS-485, Output: LoRa
		JMW10200-A159 Input: RS-485, Output: GSM(PRS/3G/4G)
		JMW10200-A162 Input: RS-485, Output: NBIOT
	EST1000-A	JMW10200-A457 Input: 1-wire, Output: ZigBee
		JMW10200-A458 Input: 1-wire, Output: LoRa
		JMW10200-A459 Input: 1-wire, Output: GSM-(PRS/3G/4G)
		JMW10200-A462 Input: 1-wire, Output: NBIOT
--	JMW20200-0C	Coordinator
--	JMW20200-0R	Router

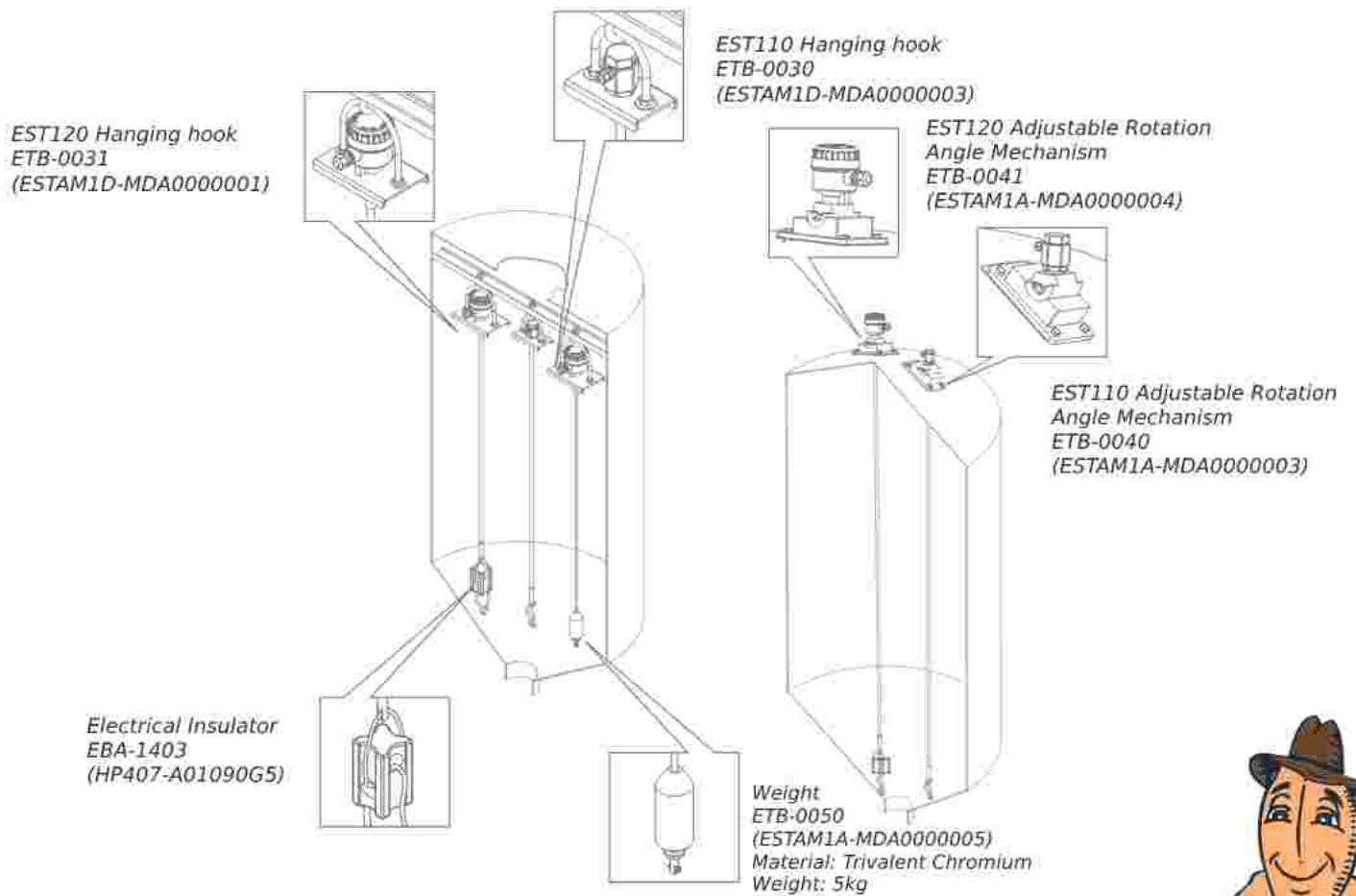

**Application Example**

**CASE 1: EST10000-A**

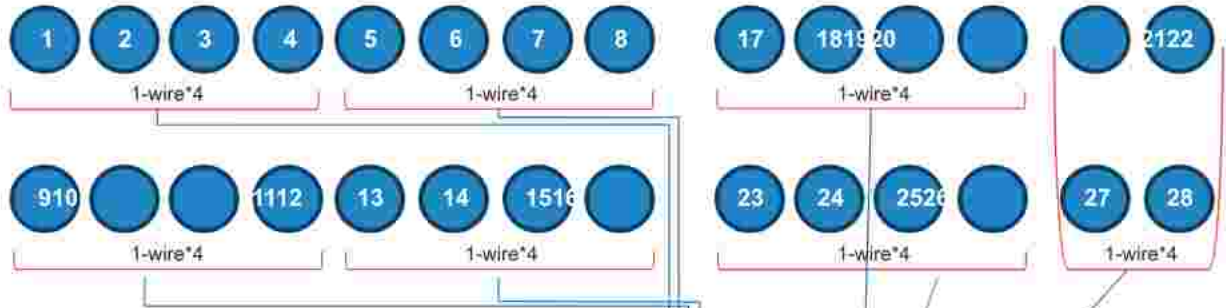

Grain silo \*28 pcs  
Each tank is installed with an EST10000-A

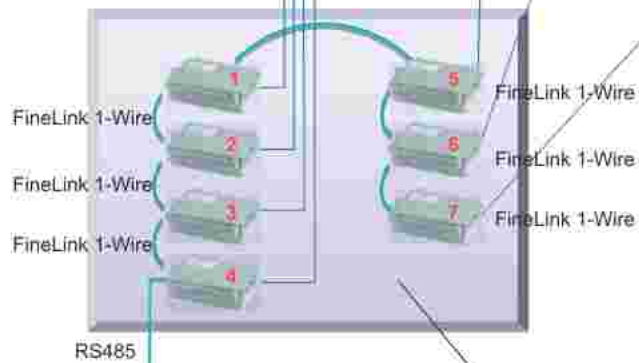

FineLink 1-wire \*7pcs  
(Each FineLink 1-wire can connect to a maximum of 4 EST10000-A sensors.)

**CASE 2: EST10000-B**

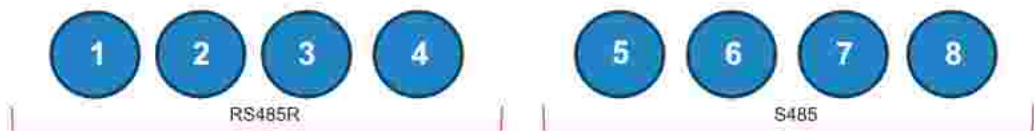

Grain silo \*8 pcs  
Each tank is installed with an EST10000-B

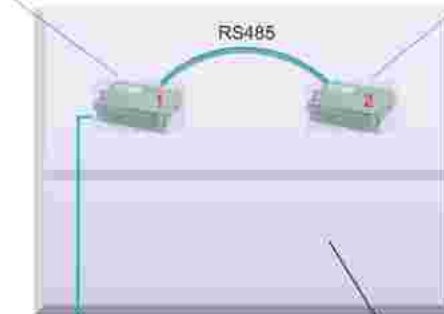

FineLink 1-wire \*2pcs  
(Each FineLink RS0485 can connect to a maximum of 4 EST10000-B sensors.)



**Application Example**

**CASE 3: EST10000-A + EST10000-B**

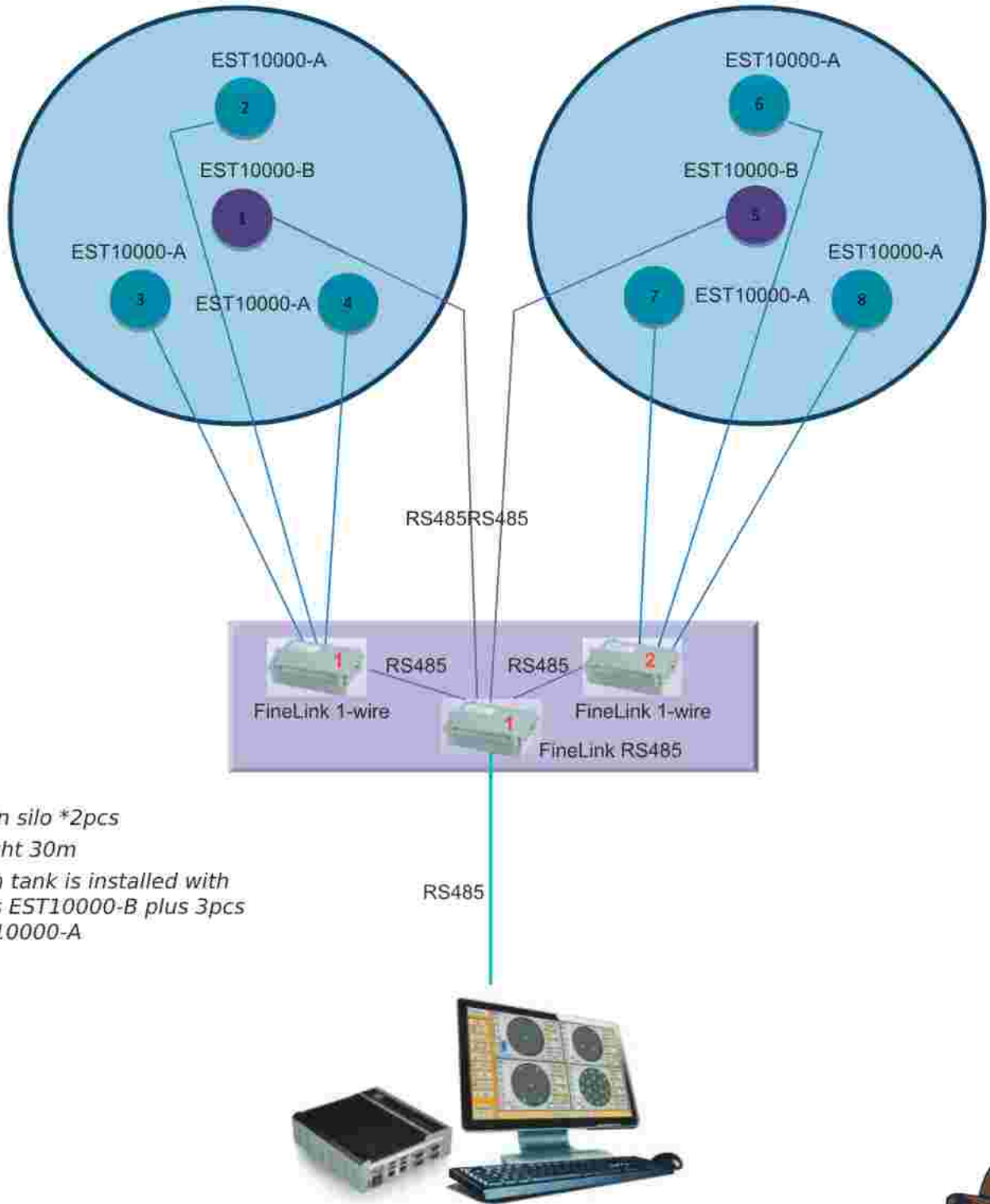

Grain silo \*2pcs  
 Height 30m  
 Each tank is installed with  
 1pcs EST10000-B plus 3pcs  
 EST10000-A



**Successful Stories**



**EST10000-B**



**FINELINK RS485**



**FINELINK 1-WIRE**



**EST10000-B**



**EST10000-A**

